

# WSSC Water Volume-Based Interceptors - General Specifications

Volume-Based Grease Interceptors (VBGI) and Volume-Based Oil and Sand Interceptors should be submitted to the WSSC Water Plumbing-Mechanical Engineering Review Section for approval prior to purchase.

## Definitions

Assembly - inlet or outlet, including pipe, tee, and diffuser

Baffle - interior vertical wall or partition

Capacity - the volume of effluent below the static level

Chamber - single portion or partitioned section of grease interceptor

Diffuser - the lowest submerged part of inlet or outlet assembly where effluent enters or leaves assembly

Pass-thru - Slot or hole in baffle to allow transfer of effluent between chambers

Static Level - level of effluent in interceptor under normal, undisturbed conditions

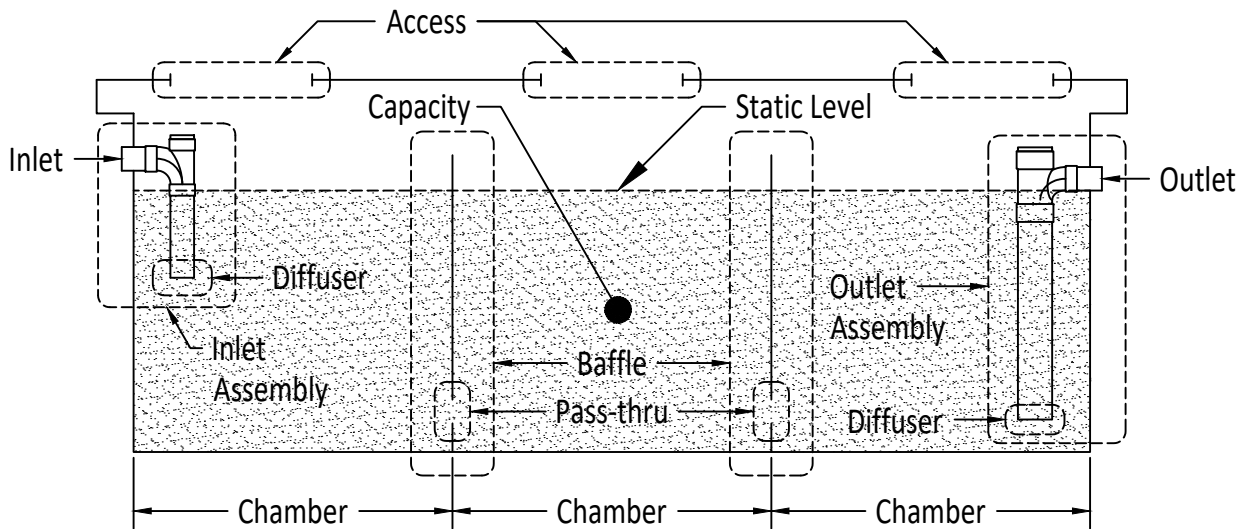

SCHMATIC OF DEFINITIONS

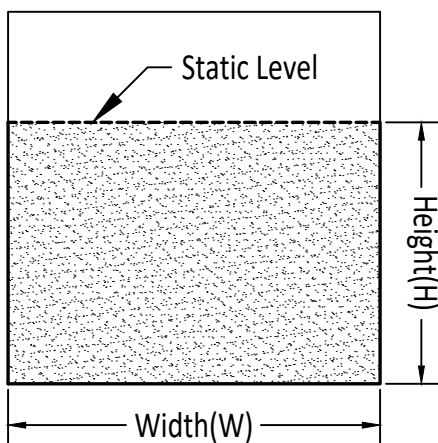

L = Length

$$\text{Capacity rectangular tank} = H * W * L$$

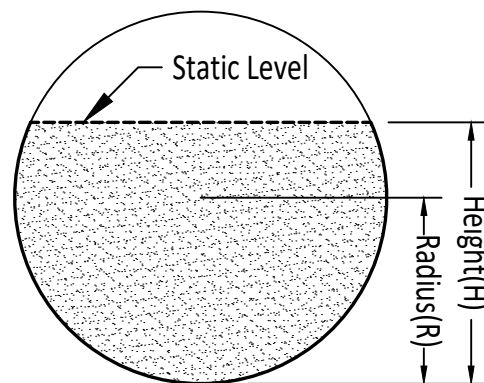

L = Length

$$\text{Capacity cylindrical tank} = R^2 * \cos^{-1} \left( \frac{R-H}{R} \right) - (R-H) * \sqrt{2 * R * H - H^2} * L$$

## Construction

All VBGs shall be designed to H-20 traffic loading standards and engineered for the proposed burial depth or capable of free standing in an above grade installation, as applicable. Precast concrete interceptors shall conform to the structural requirements contained in ASTM C1613 Standard Specification for Precast Concrete Interceptor Tanks. Baffles for precast concrete interceptors shall be monolithic with tank bottom and sidewalls. Pipe and pipe fittings shall conform to building sewer pipe per latest edition of WSSC Plumbing and Fuel Gas Code(WSSC Code). Baffles shall be provided by manufacturer and not fabricated by plumber.

## WSSC Code

In general, VBGs shall comply with WSSC Code 302.10.1/1003.6 - Volume-Based Grease Interceptors.

## Access

Access requirements shall follow WSSC Code 302.10.1/1003.6.2.6 & 1003.6.2.7 and WSSC Standard Details.

## Oil/sand interceptors

In general, the same design shall be used for oil/sand interceptors with the following exception,

Where the drainage receptors don't have traps (untrapped) the inlet assembly shall be an elbow instead of a tee and the tank or the outlet piping shall be vented.

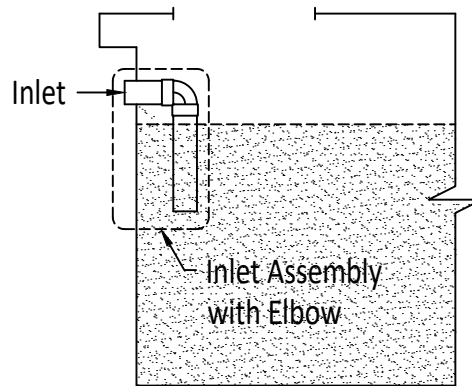

SIDE SECTION VIEW - INLET ASSEMBLY FOR OIL/SAND INTERCEPTORS  
CONNECTED TO UNTRAPPED DRAINS

## Tank Size and Numbers of Chambers

Capacity (Gallons)	Minimum Number of Chambers
300 - 500	1
501 - 1,000	2
1,001+	3

## Inlet and Outlet Elevations

Outlet invert elevation shall be a minimum 3" lower than inlet invert elevation.

**Chamber Sizes**

Number of Chambers	Chamber Size (Percentage of Total Capacity)	
	Minimum	Maximum
1	100%	
2	40%	60%
3	30%	40%
4+	Consult with WSSC Water	

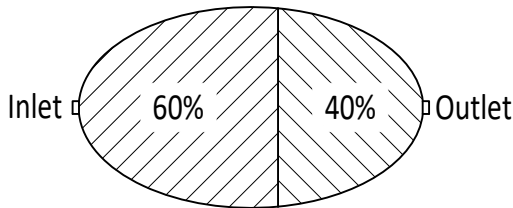

**TOP VIEW - EXAMPLE OF ELLIPTICAL CYLINDER TANKS WITH 2 CHAMBERS**

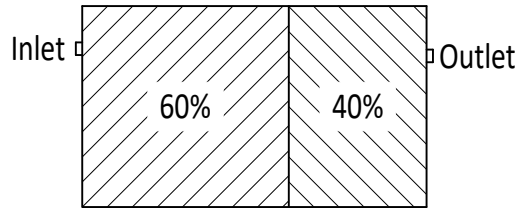

**SIDE VIEW - EXAMPLES OF RECTANGULAR TANKS WITH 2 CHAMBERS**

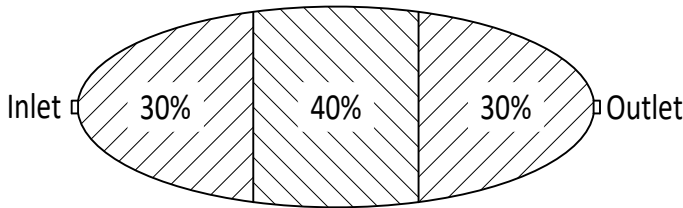

**TOP VIEW - EXAMPLE OF ELLIPTICAL CYLINDER TANKS WITH 3 CHAMBERS**

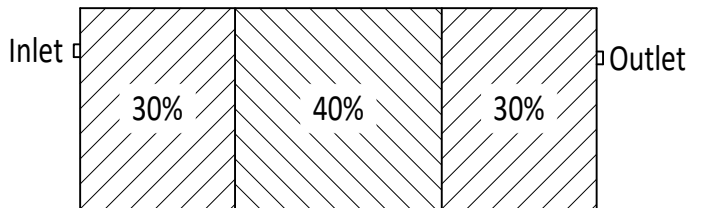
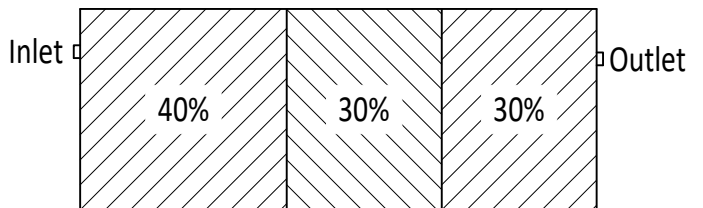

**SIDE VIEW - EXAMPLES OF RECTANGULAR TANKS WITH 3 CHAMBERS**

**Inlet/Outlet Pipe Sizes**

Capacity (Gallons)	Inlet/Outlet Connection Size	
	Minimum	Maximum
300 - 1,000	3"	4"
1,001 - 2,000	4"	4"
2,001 - 7,500	6"	6"
7,501+	8"	8"

## Inlet Assembly (pipe and diffuser)

1. Shall create a vertical tee with horizontal portion connected to inlet piping and openings at top and bottom.
2. The top opening of assembly shall,
  - a) be located at an elevation that is a minimum distance of 1.5 times the inlet pipe diameter above the static level.
  - b) have a size equal to or greater than the cross-sectional area of inlet pipe.
3. The bottom opening(diffuser) of assembly shall,
  - a) be located at a minimum elevation of  $\frac{1}{2}$  the distance from bottom of interceptor to static level and maximum elevation of  $\frac{1}{3}$  of the distance from bottom of interceptor to static level.
  - b) have a minimum size equal to cross-sectional area of inlet pipe and maximum size of 5 times the cross-sectional are of inlet pipe.
4. Inlet assembly shall be adequately supported to prevent damage from routine use and maintenance. WSSC recommends that the inlet assembly be supported at a minimum of two locations, the inlet and the diffuser.

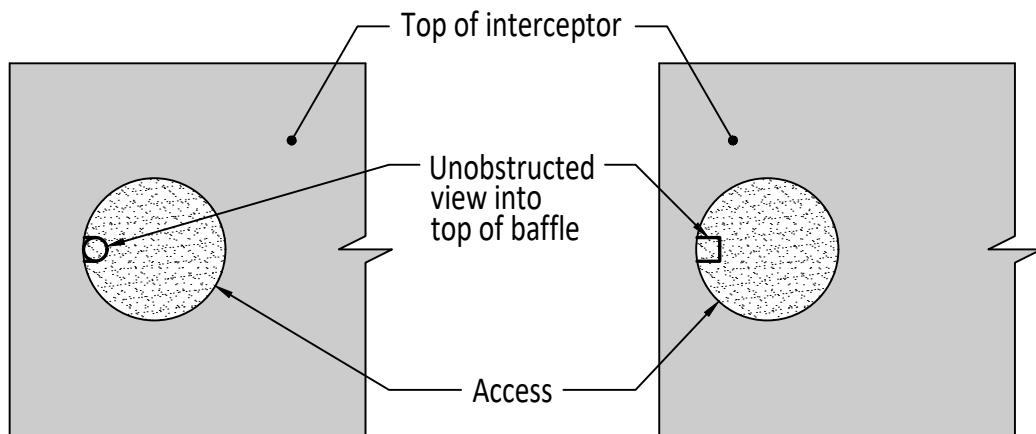

TOP VIEW - INLET ASSEMBLY

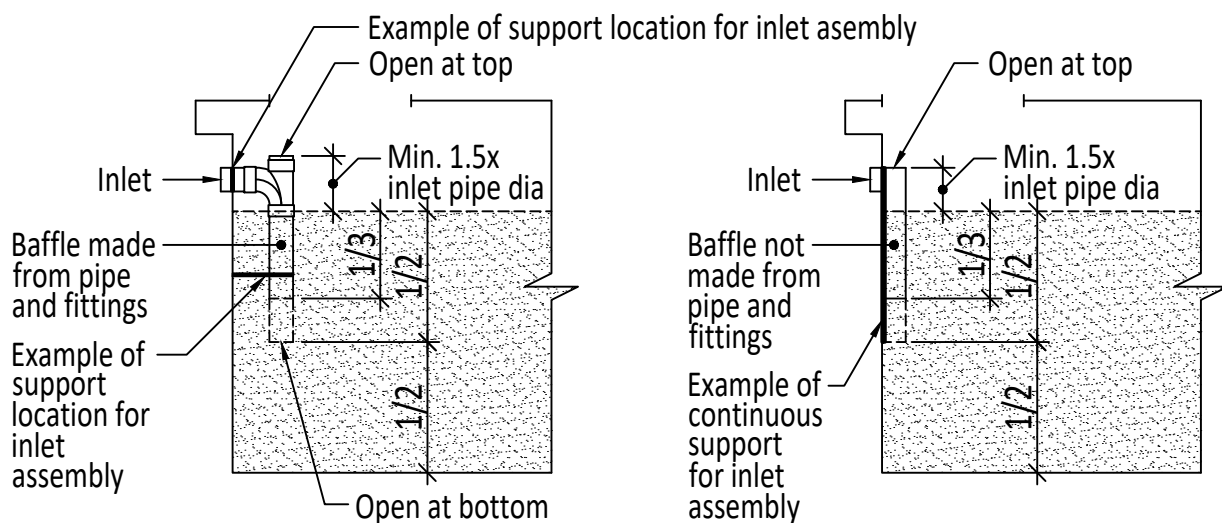

SIDE SECTION VIEW - INLET ASSEMBLY

## Baffles

1. Each wall shall be capable of withstanding the maximum hydraulic load of differing levels of chamber contents.
2. For all tank types the baffles shall be constructed and sealed to not allow transfer of liquids or solids between chambers except for at pass-thru.
3. Baffles shall extend from bottom of interceptor to no closer than 1 inch of underside of tank top/cover and top of baffle wall shall be at an elevation that is a minimum distance of 1.5 times the inlet pipe diameter above the static line.

As an alternative, all baffle walls between chambers(for all interceptor types) may be sealed at the top where a vent hole(s)/slot/opening is provided as follows:

- a) Bottom of hole(s)/slot/opening a distance of 1.5 times the inlet pipe diameter above the static line.
  - b) Total cross-sectional area of hole(s) shall be a minimum of 50% of cross-sectional area of outlet piping.
4. Each wall shall incorporate a pass-thru consisting of either,
    - a) a minimum of three holes, each with the diameter of the inlet piping
    - b) a slot with minimum total cross-sectional area equal 3 times the cross-sectional area of inlet piping and a minimum vertical dimension of 2"
  5. The pass-thru shall be located at an elevation so the opening(s) are located with 20% of the tank capacity below the top of pass-thru (for tanks with rectangular cross-section this is equal to  $1/5$  of the distance from bottom of interceptor to static level).
  6. The pass-thru shall be located at an elevation so the bottom of the opening(s) is located at a minimum distance of half the diameter of inlet piping from the bottom of tank.

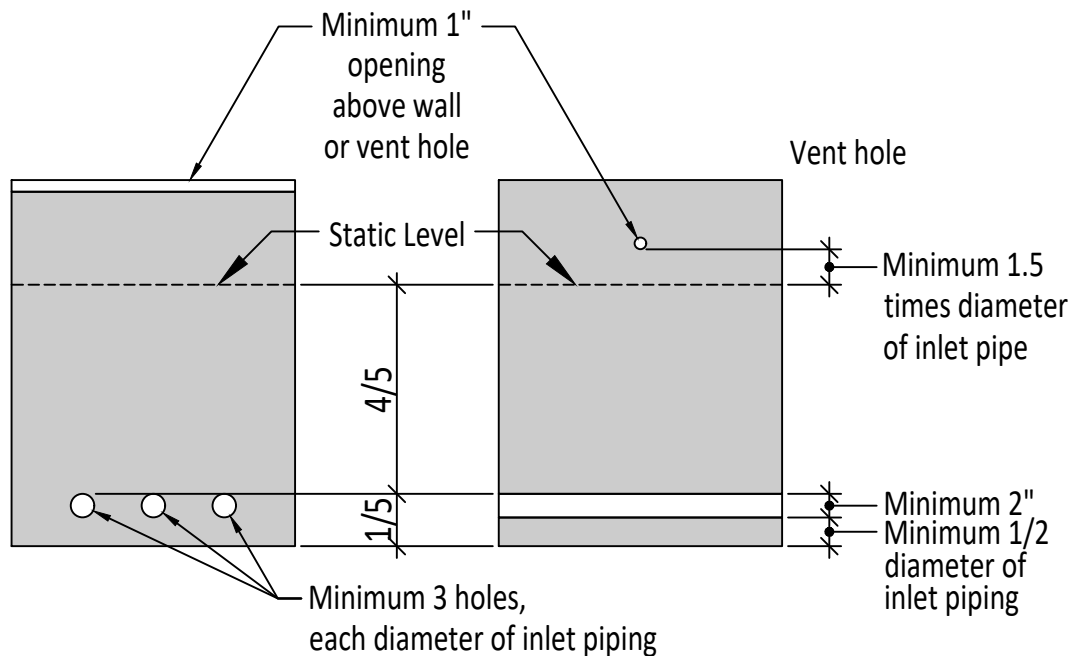

EXAMPLES OF BAFFLE WALLS

## Outlet Assembly (pipe and diffuser)

1. Shall create a vertical tee with horizontal portion connected to inlet piping and openings at top and bottom.
2. The top opening of assembly shall
  - a) be located at an elevation that is a minimum distance of 1.5 times the outlet pipe diameter above the static level.
  - b) have a size equal to or great than the cross-sectional area of inlet pipe.
3. The bottom opening(diffuser) of assembly shall,
  - a) be positioned so the top of the opening(s) establish a horizontal plane with 20% of the tank capacity below the opening(for tanks with rectangular cross-section this is equal to 1/5 of the distance from bottom of interceptor to static level).
  - b) be minimum 1.5 times the cross-sectional area of inlet pipe(one nominal size larger), up to 5 times max.
4. Outlet assembly shall be adequately supported to prevent damage from routine use and maintenance. WSSC recommends that the inlet assembly be supported at a minimum of two locations, the inlet and the diffuser.

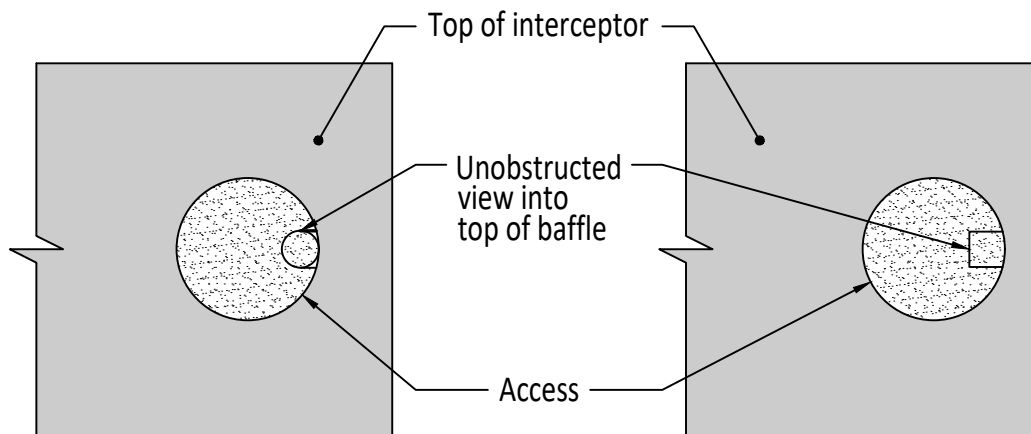

TOP VIEW - OUTLET ASSEMBLY

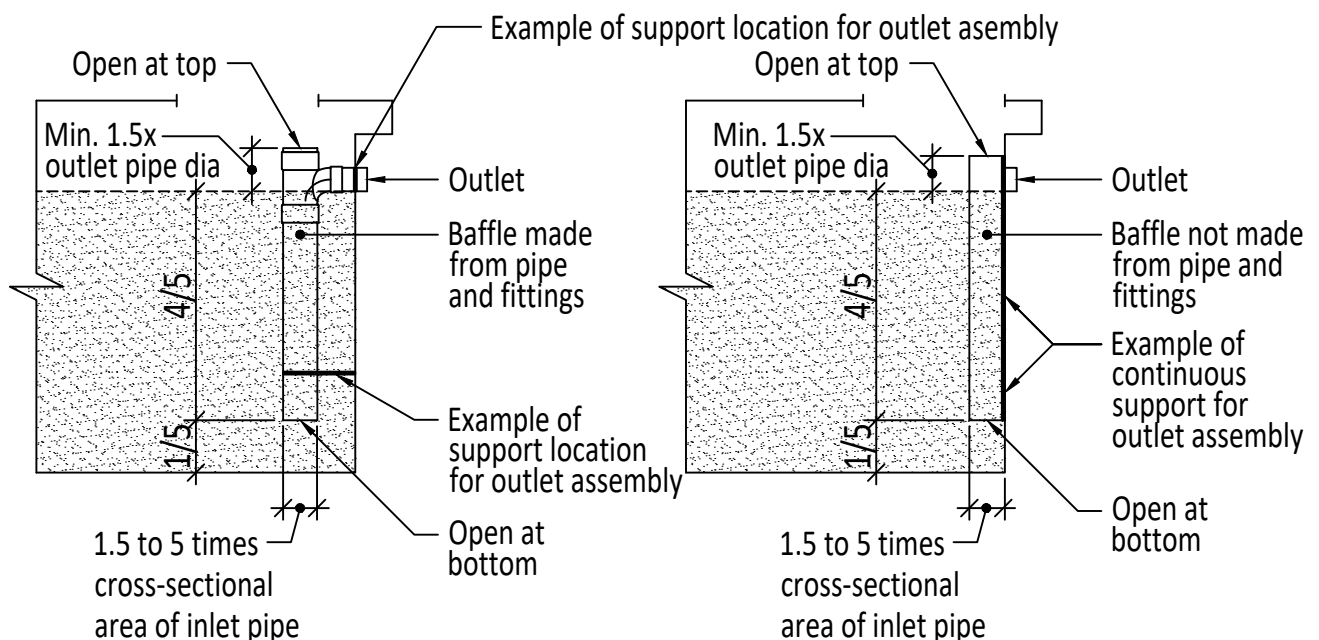

SIDE SECTION VIEW - OUTLET ASSEMBLY